

Growing a sustainable future

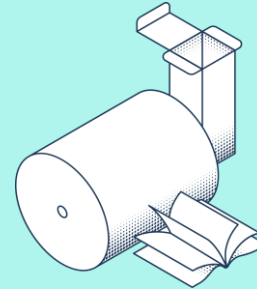

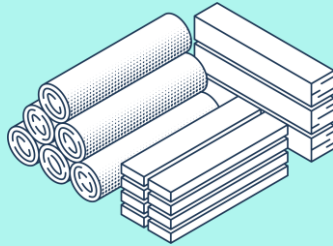

Wood products
1.5 Mm³



Packaging,
books & magazines
1.5 Mton

Harvest in own forests
2.8 Mm³

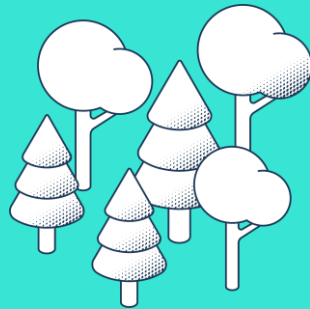

Hydro and wind power
1.8 TWh

1.3 million ha total land area

Solid earnings despite slow cycle

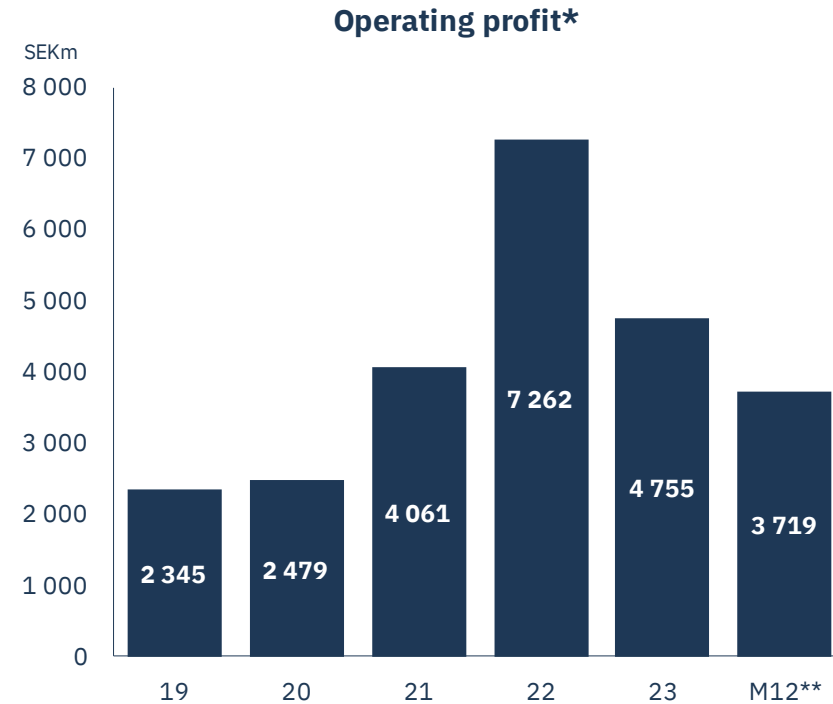
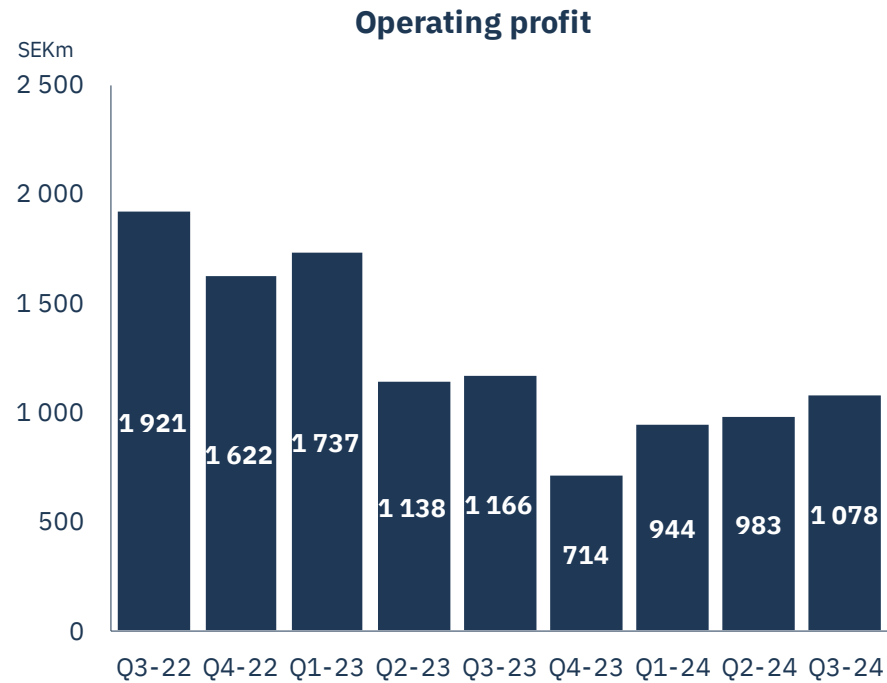

16% ROCE in our industry in the last year

18% average for the last 10 years

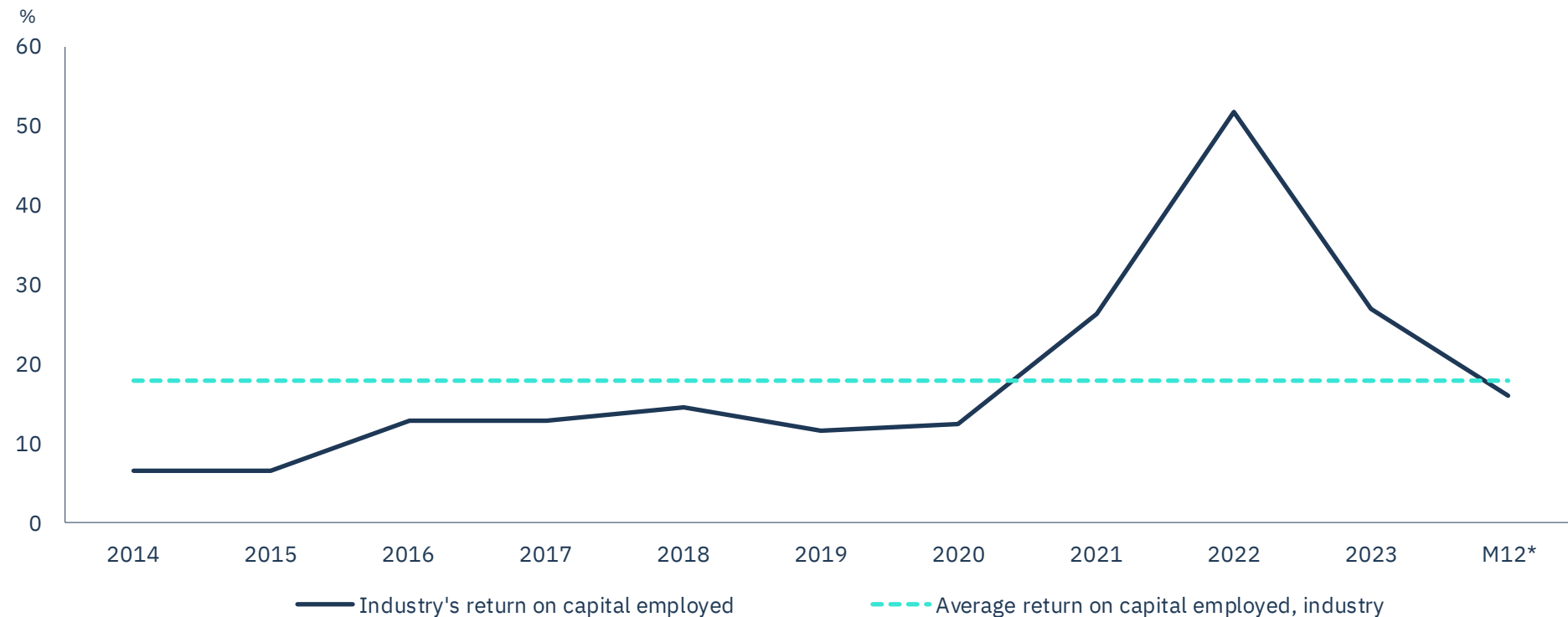

Dividends & buy-backs of SEK 6 bn 2023-2024

Net debt at 6% of equity

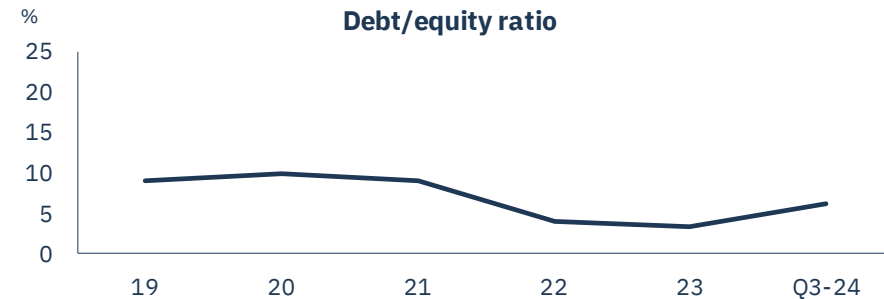
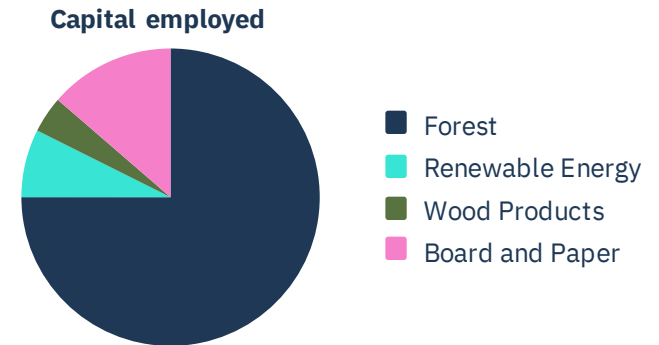
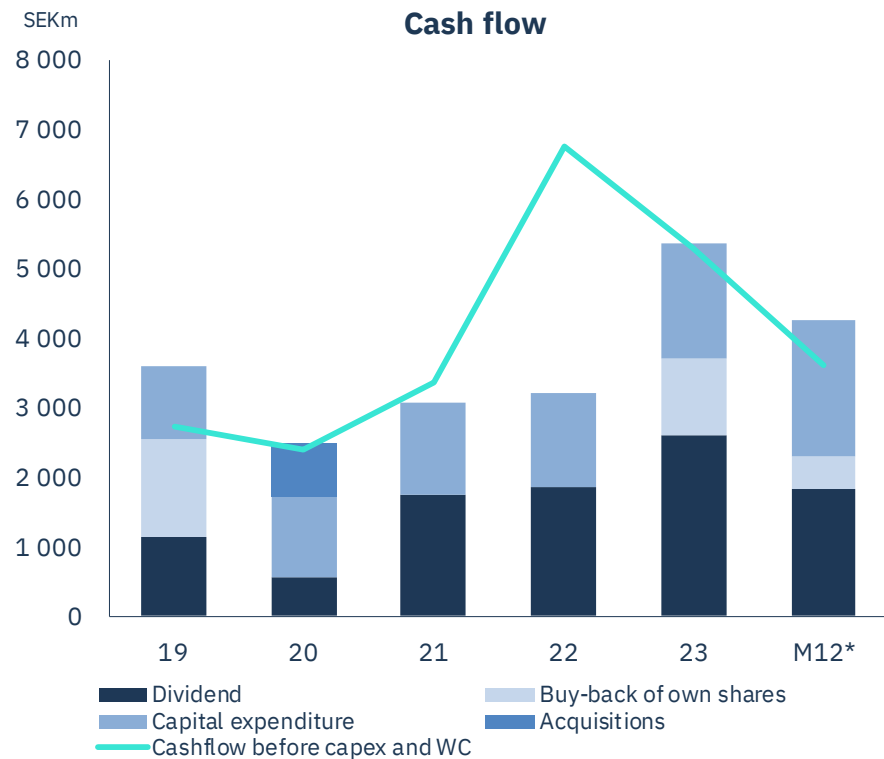

Expanding wood products and wind power

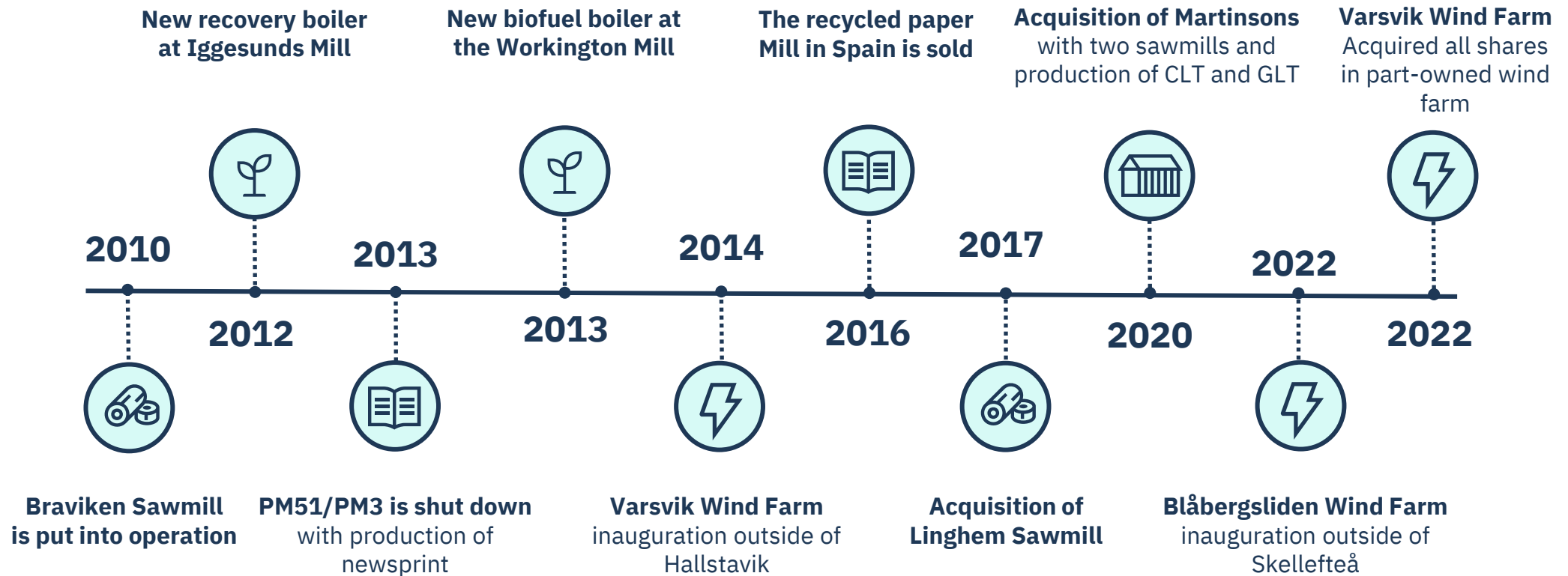

A bet on the green transition

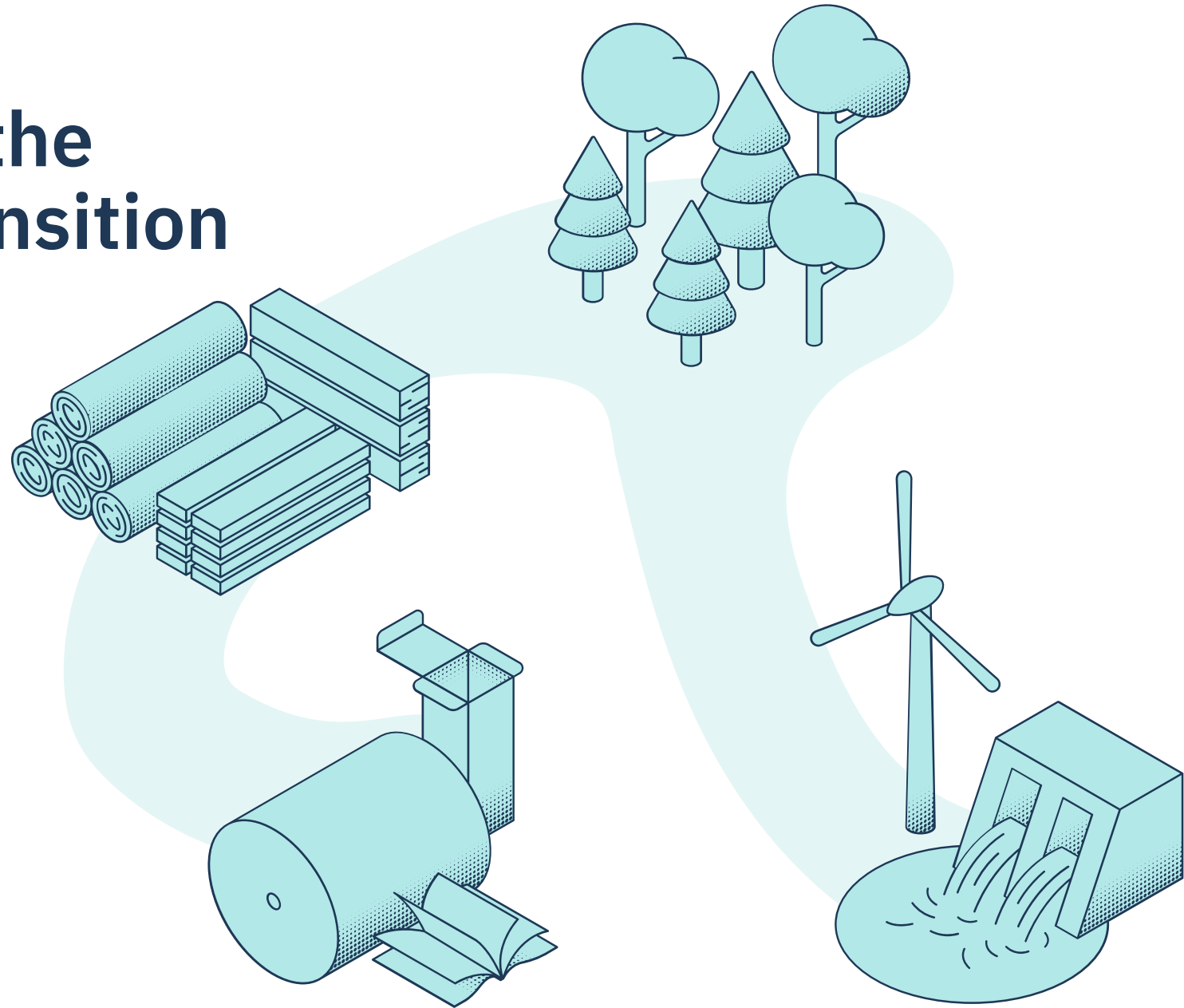

The world is fossil fueled

Fossil energy has quadrupled last 50 years

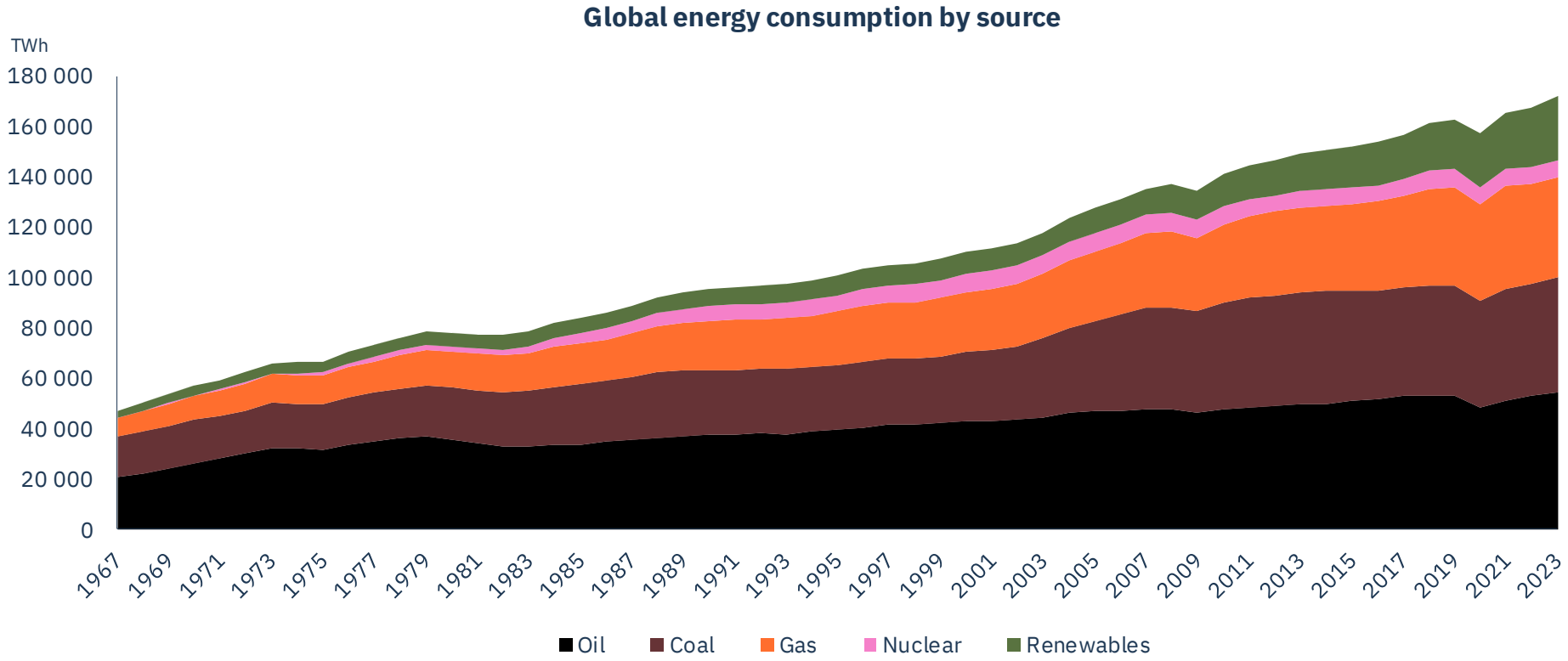

EU has high ambitions for climate & ecosystems



European industry has not decarbonised

Biodiversity is under pressure

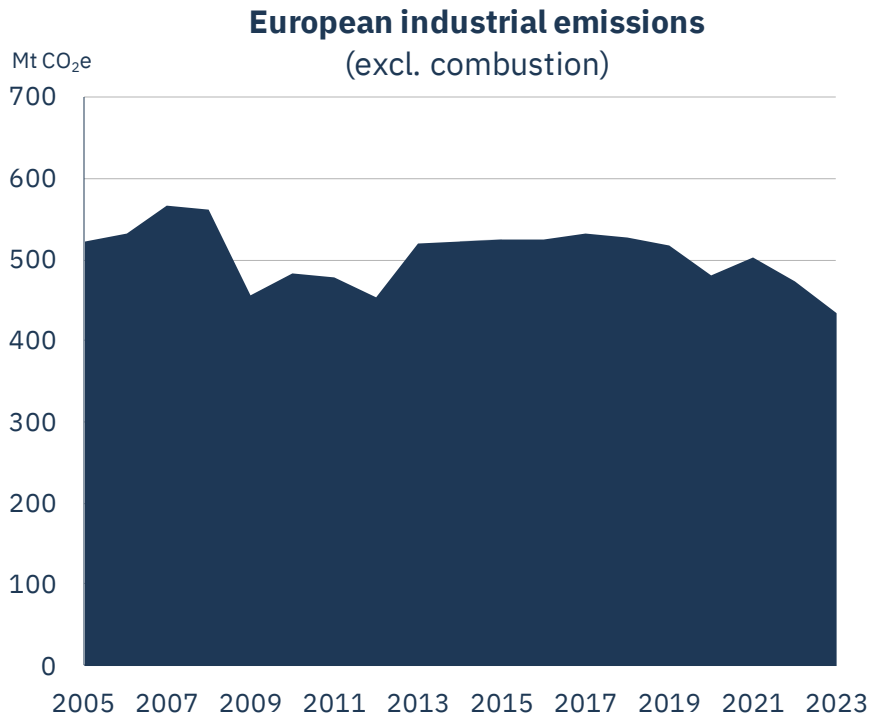

Source: European Environment Agency

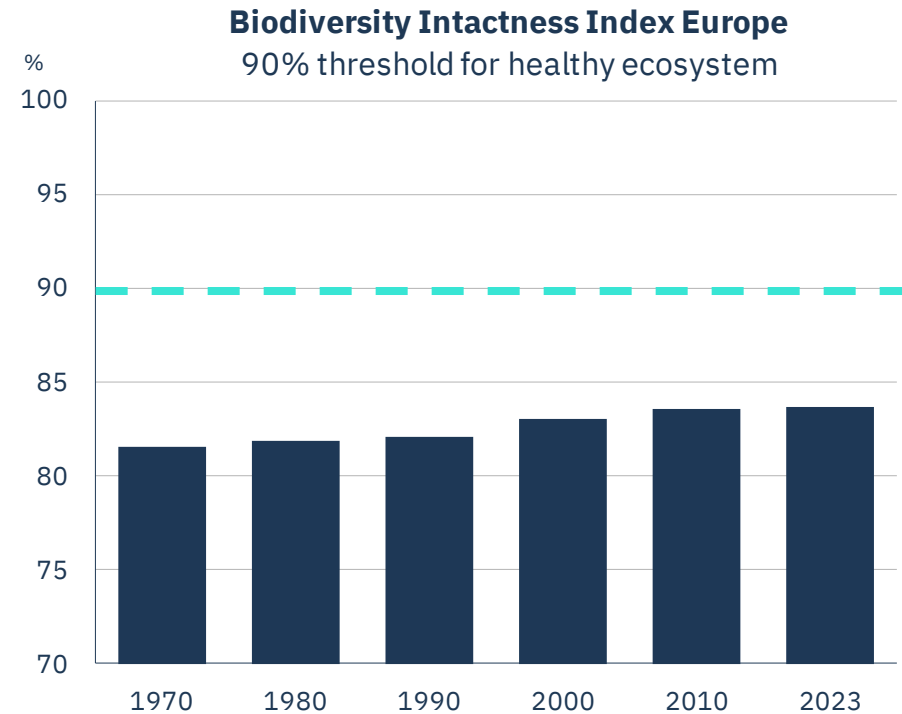

Source: [Natural History Museum](#)

We have lowered our fossil emissions by 90%

Swedish ecosystems are in balance

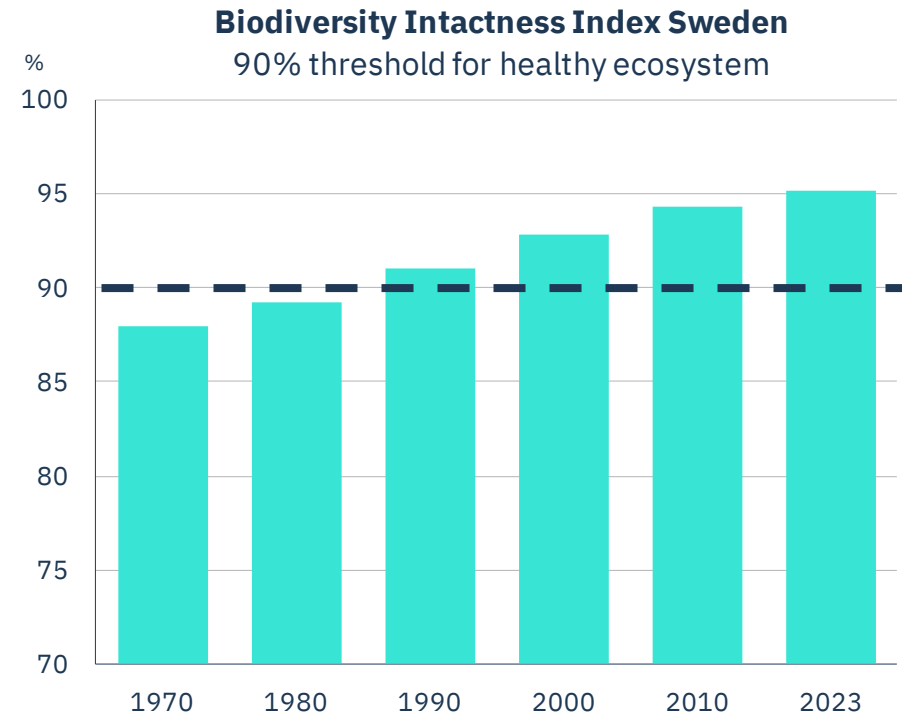
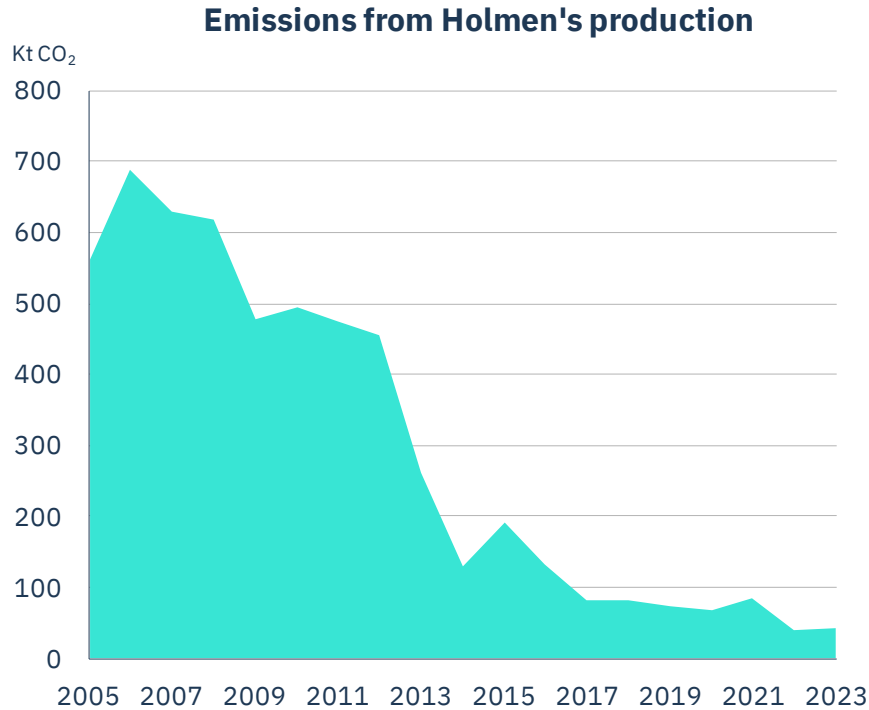

Access to wood & fossil-free energy

Forest assets*

- >65
- 51-65
- 31-50
- 11-30



Carbon intensity from electricity production**

- <100
- 101-200
- 201-300
- 301-500
- >500
- No data

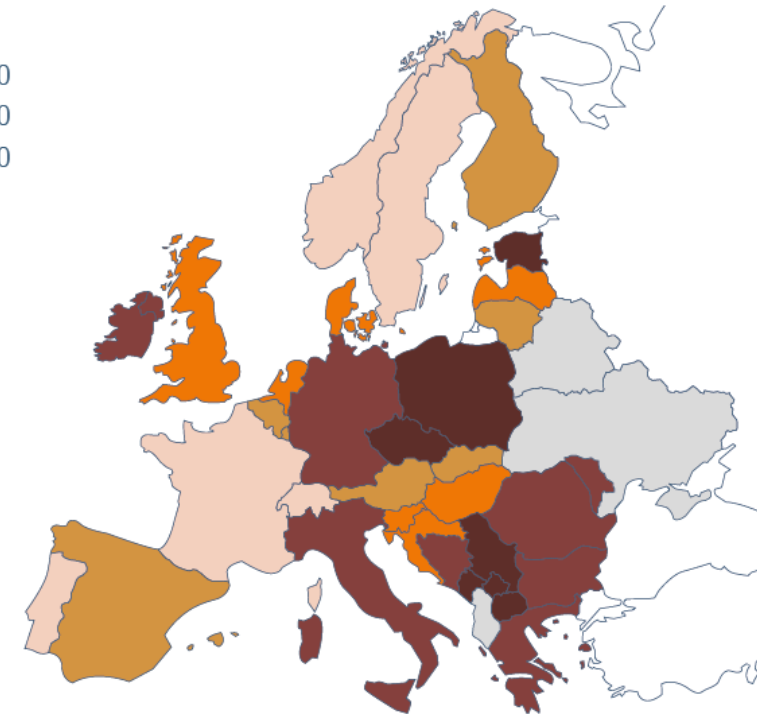

Clean air and plenty of water in the Nordics

Air pollution*

- <8
- 8–9
- 10–11
- 12–14
- >14
- No data

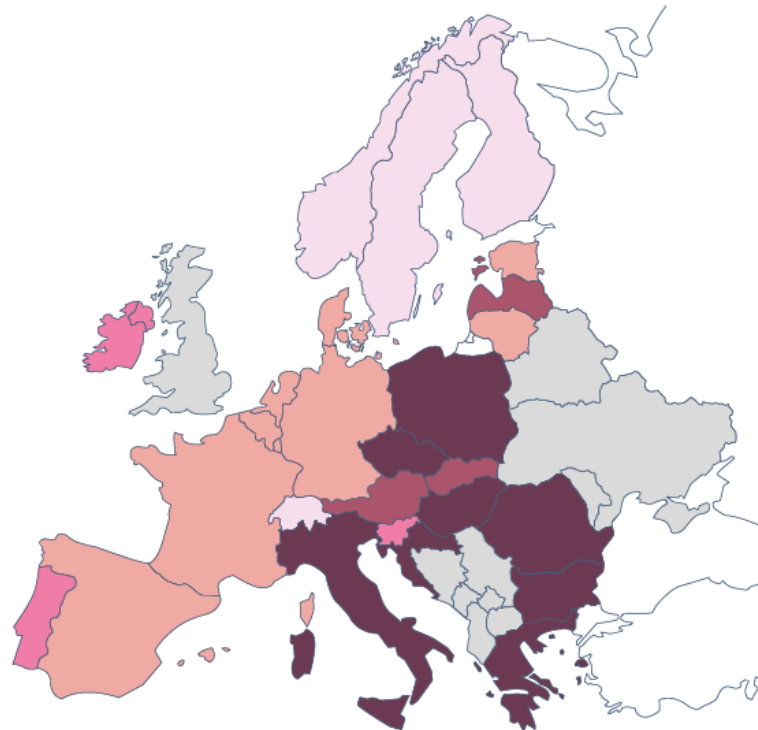

Water stress**

- Low
- Low–medium
- Medium–high
- High
- Extremely high
- No data

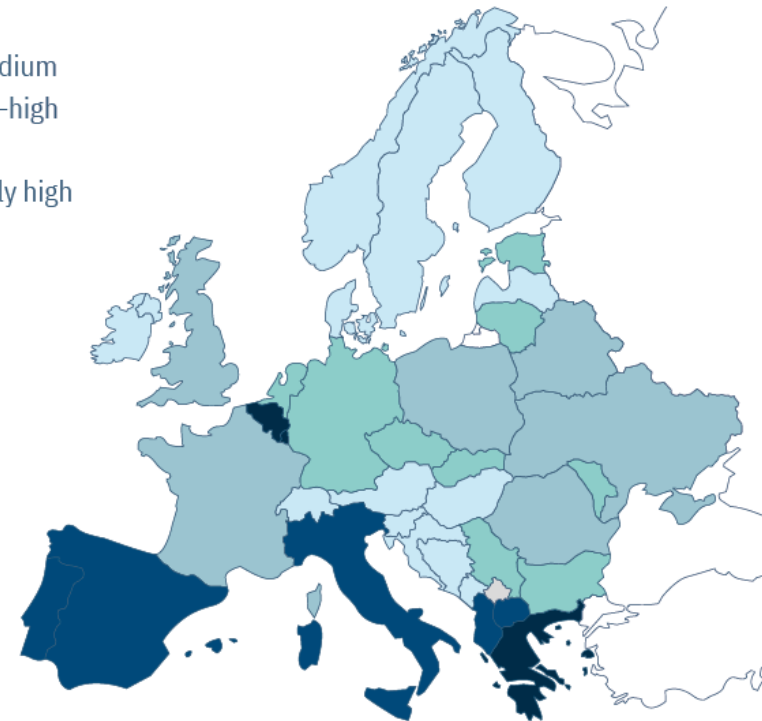

We're beyond net zero

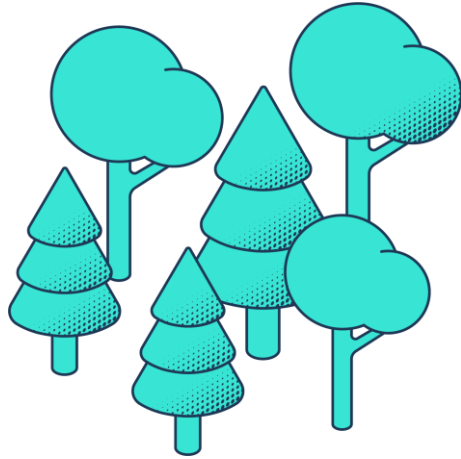

1.6 Mt CO₂
Net increase in growing forest

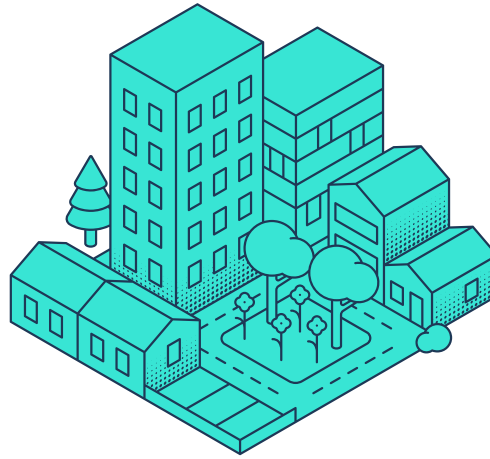

0.5 Mt CO₂
Net storage in buildings

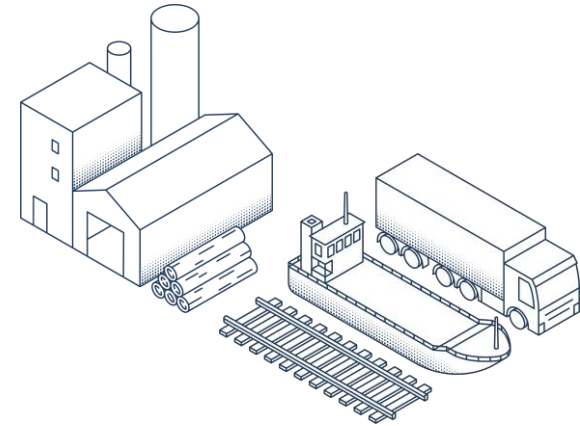

-0.1 Mt CO₂e Scope 1+2
-0.6 Mt CO₂e Scope 3

Board and Paper

1.5 million tonnes per year

Helping our customers with their CO₂ footprint

Consumer board, transport packaging, books & magazines

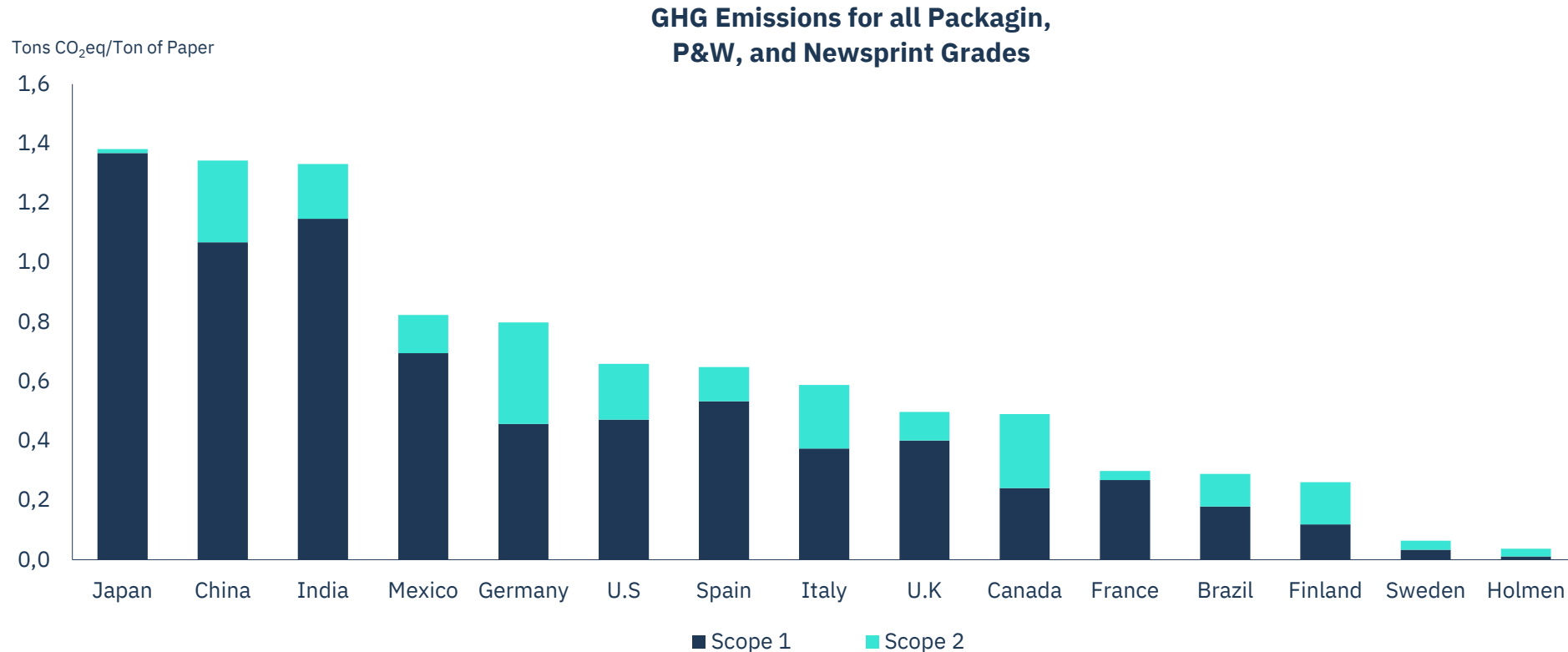

Investing to enter transport packaging

While strengthening the book offering

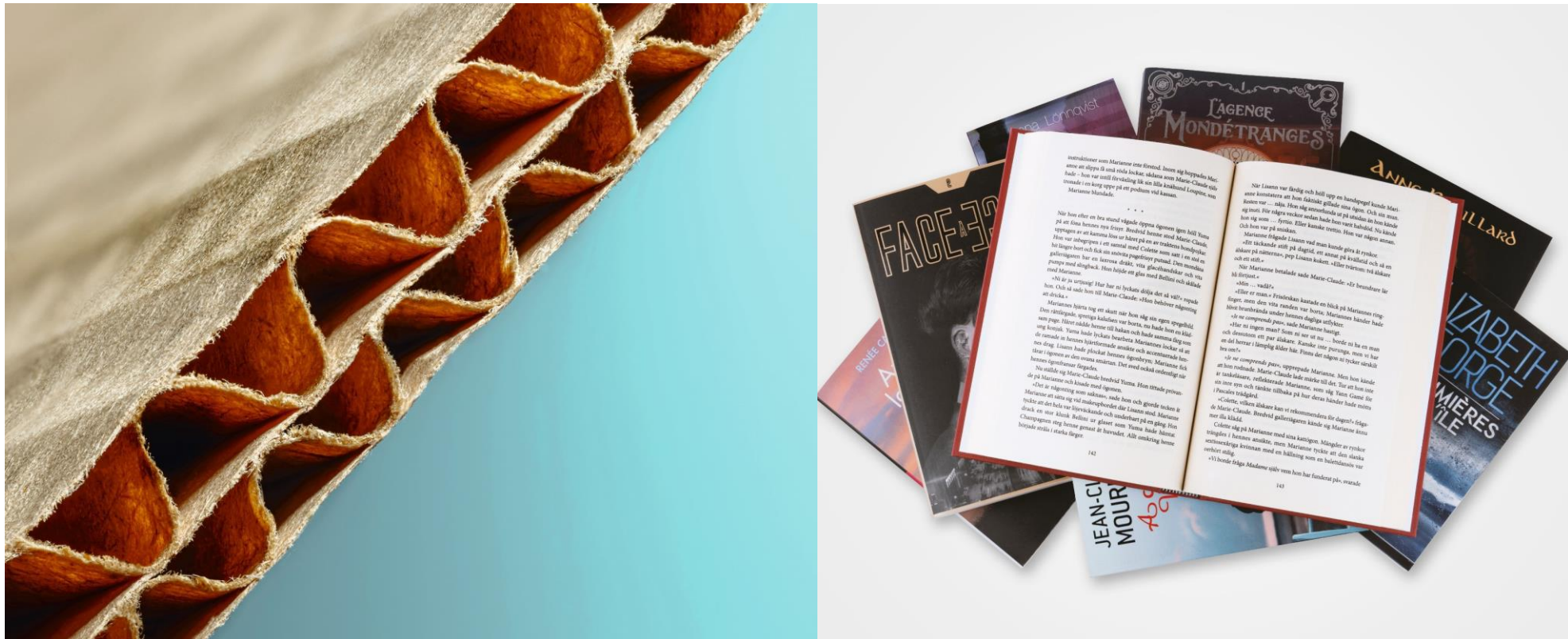

Muted consumer demand

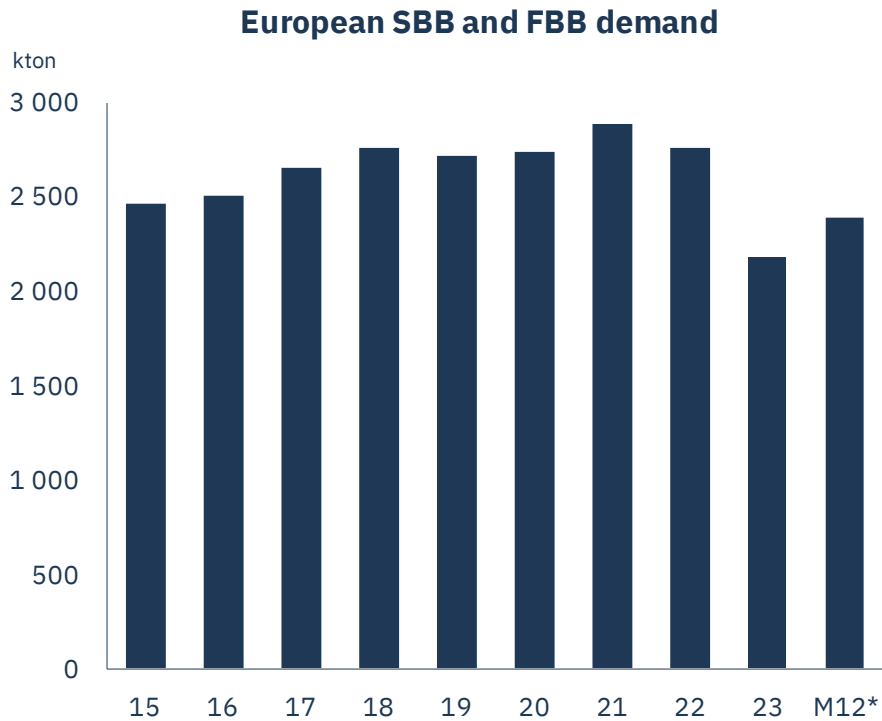

Paper consumption moving sideways

Oversupplied market

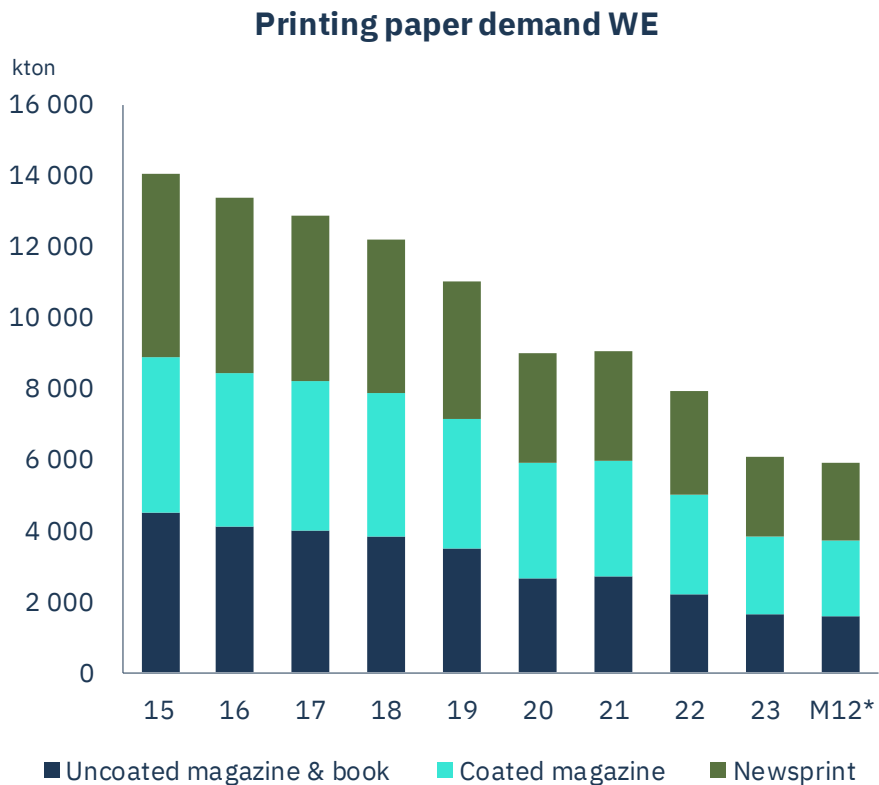

Solid ROCE over time

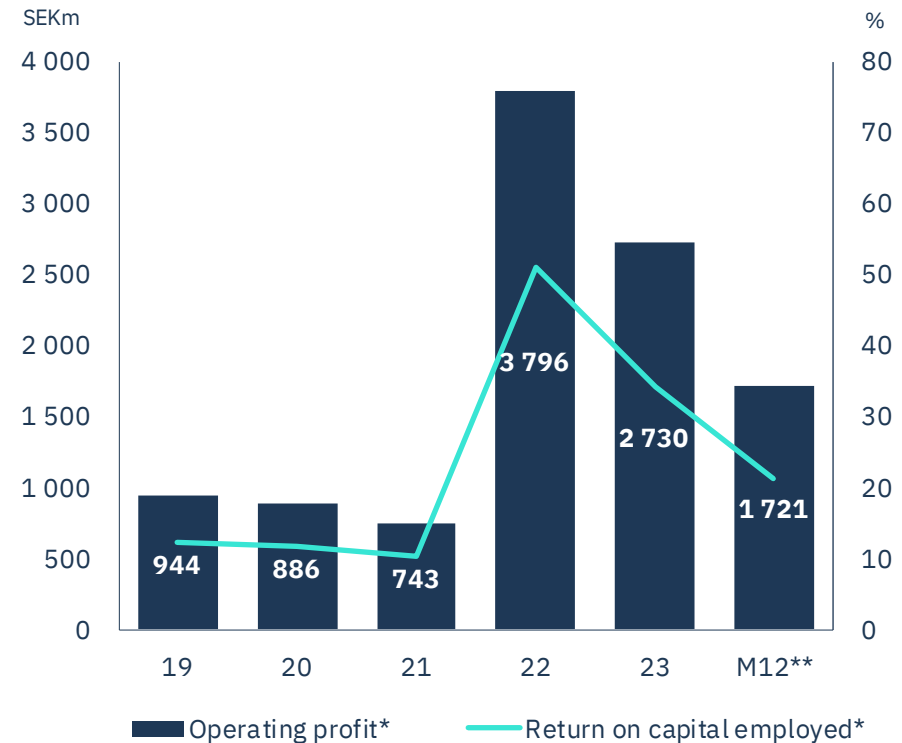
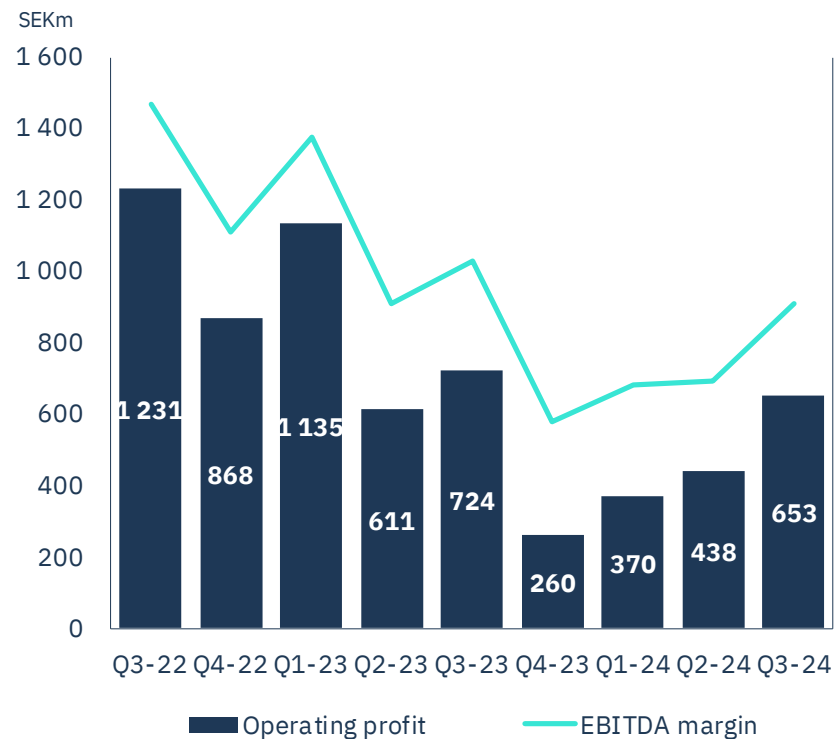

Wood Products

1.5 million m³ per year

Offer a green alternative to concrete & steel

CBAM will push up the cost for building materials

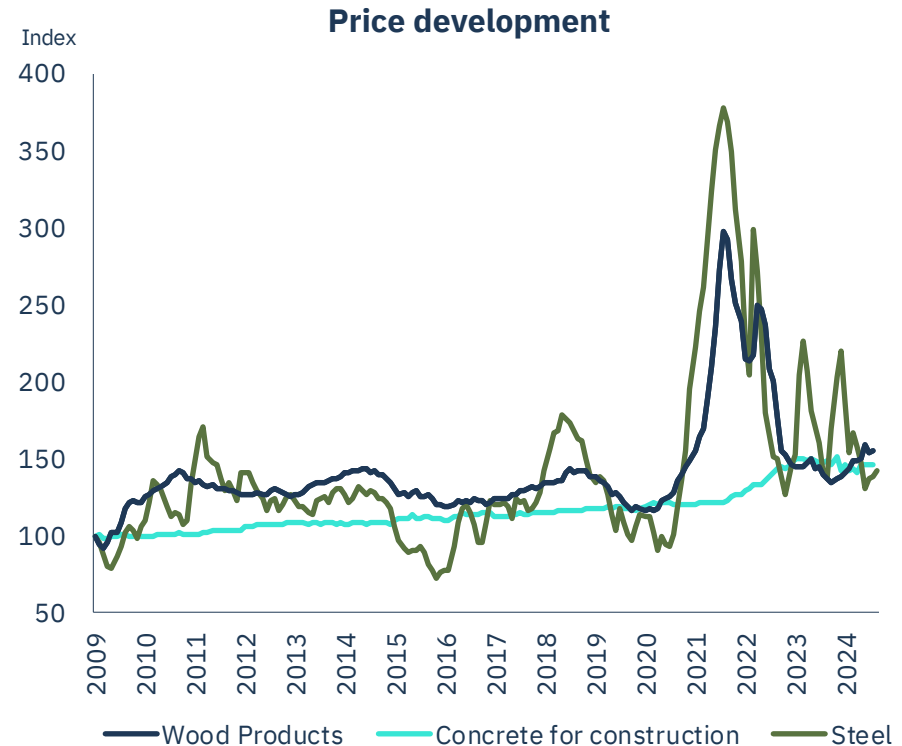
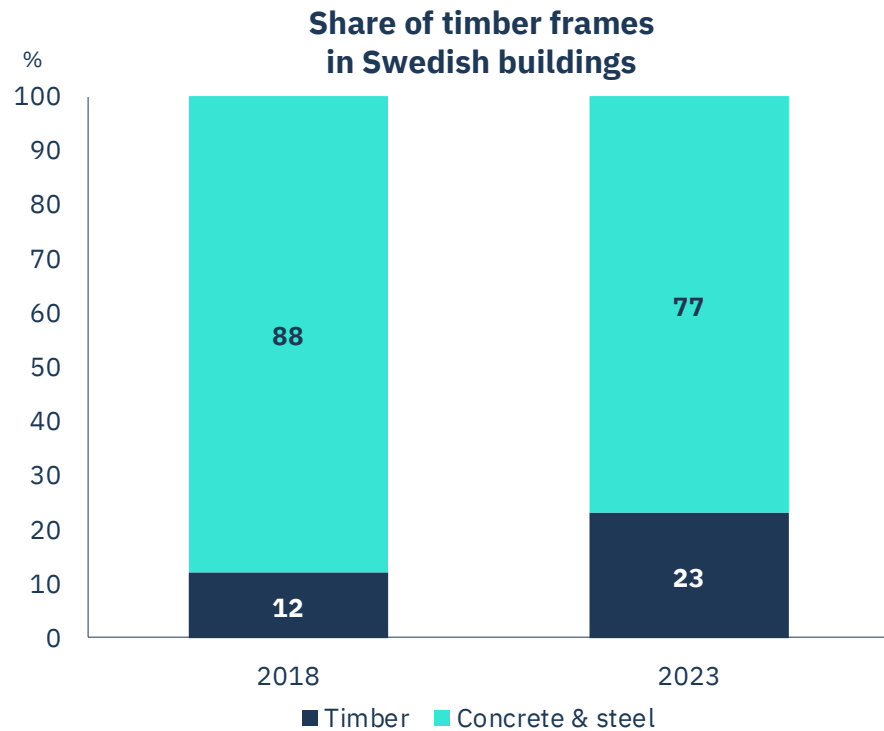

Developing our asset base with targeted Capex

- Finalising upgrade of Iggesund Sawmill
- Establishing a logistic hub at Braviken for GLT
- Ramping up CLT production after removing bottle-neck

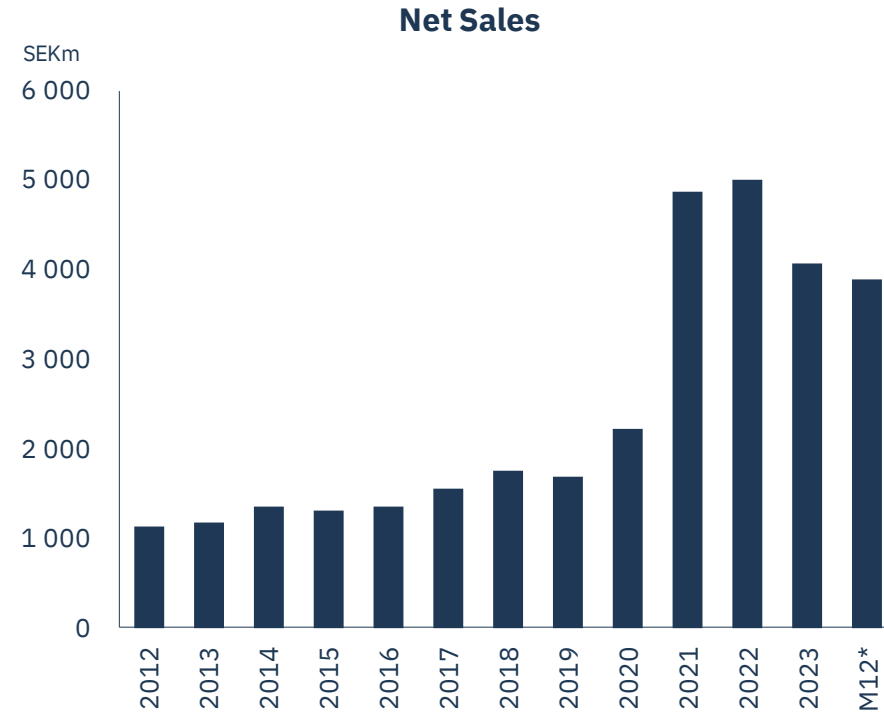

Slow constructional cycle

Prices down after seasonal up-tick in April-May

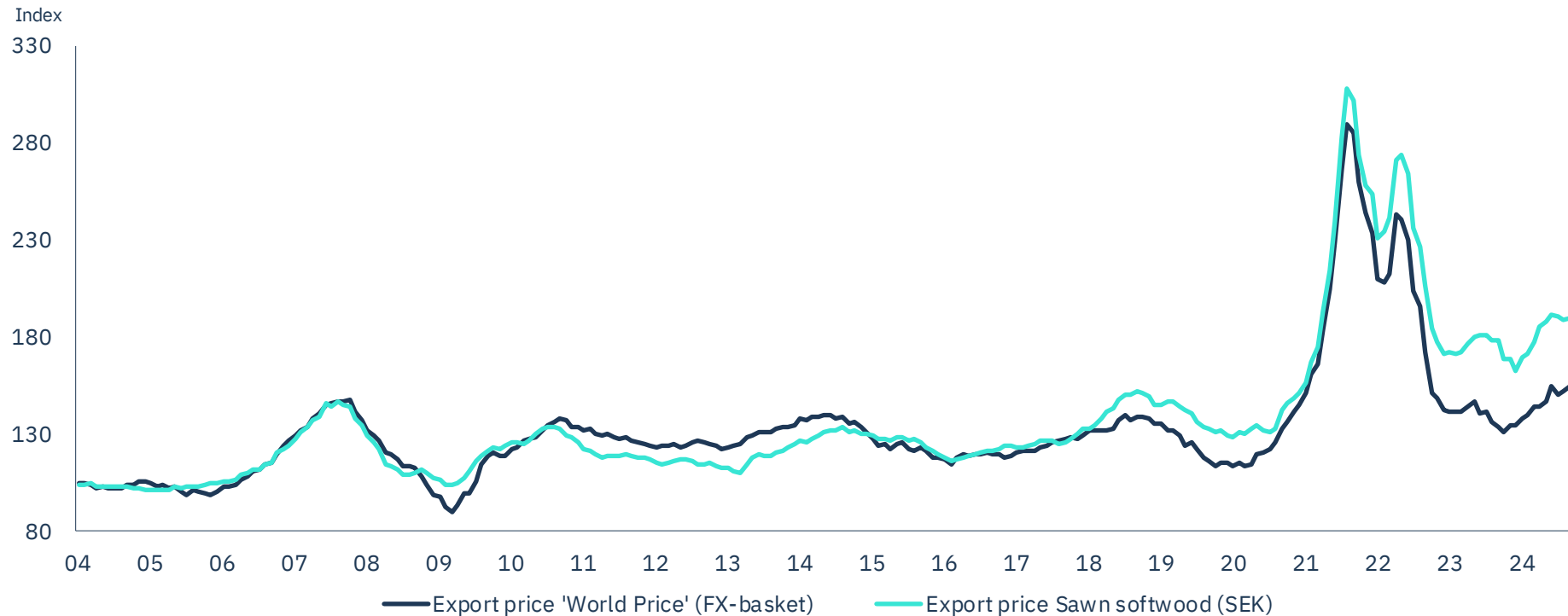

Margin under pressure from high log costs

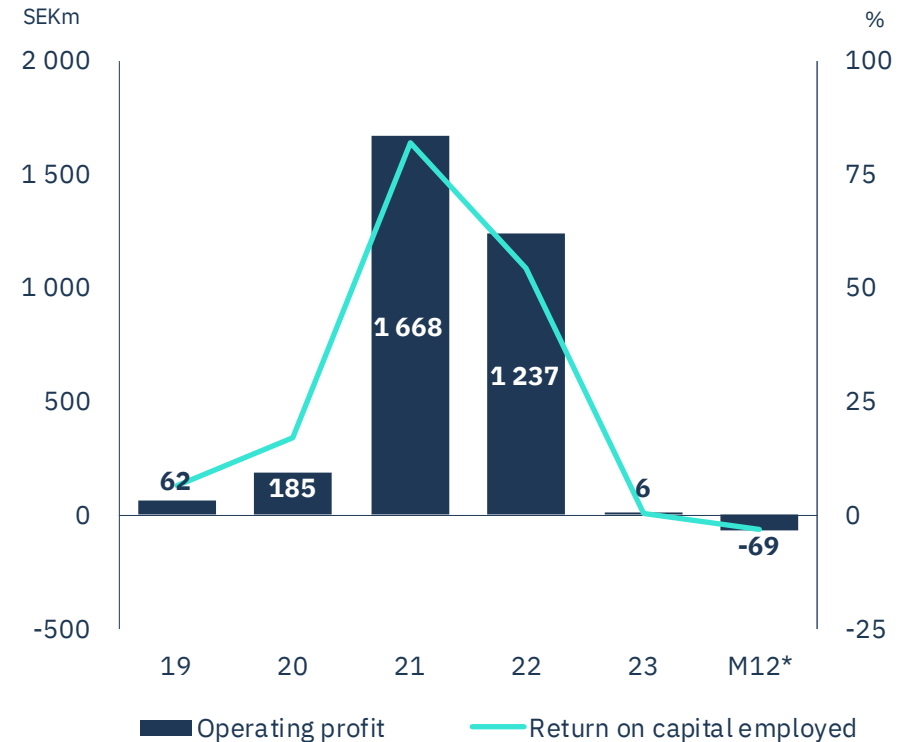
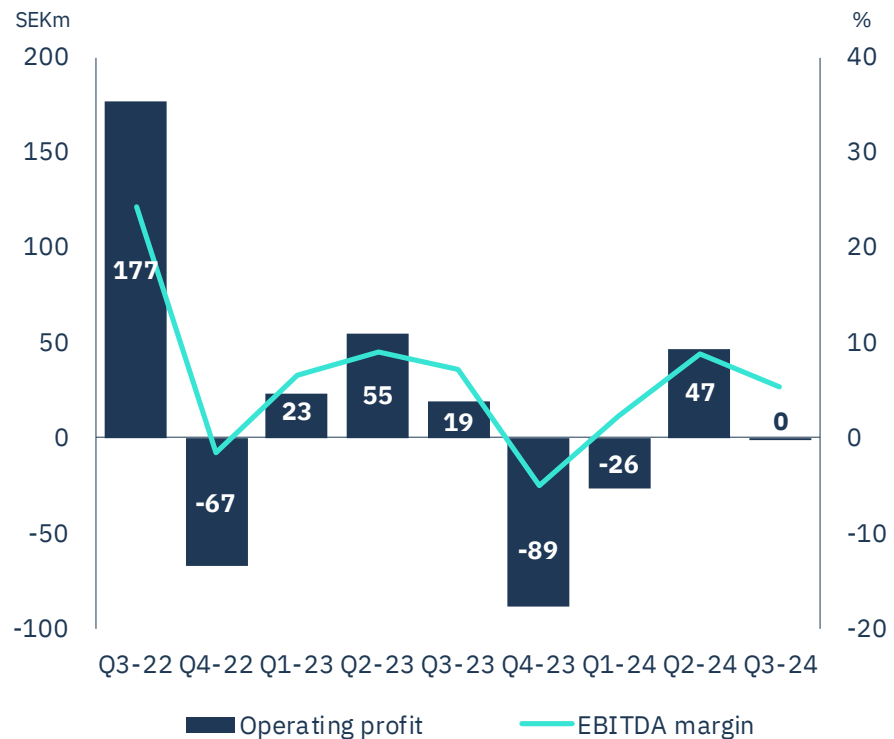

Renewable Energy

1.8 TWh per year



Developing a wind farm portfolio

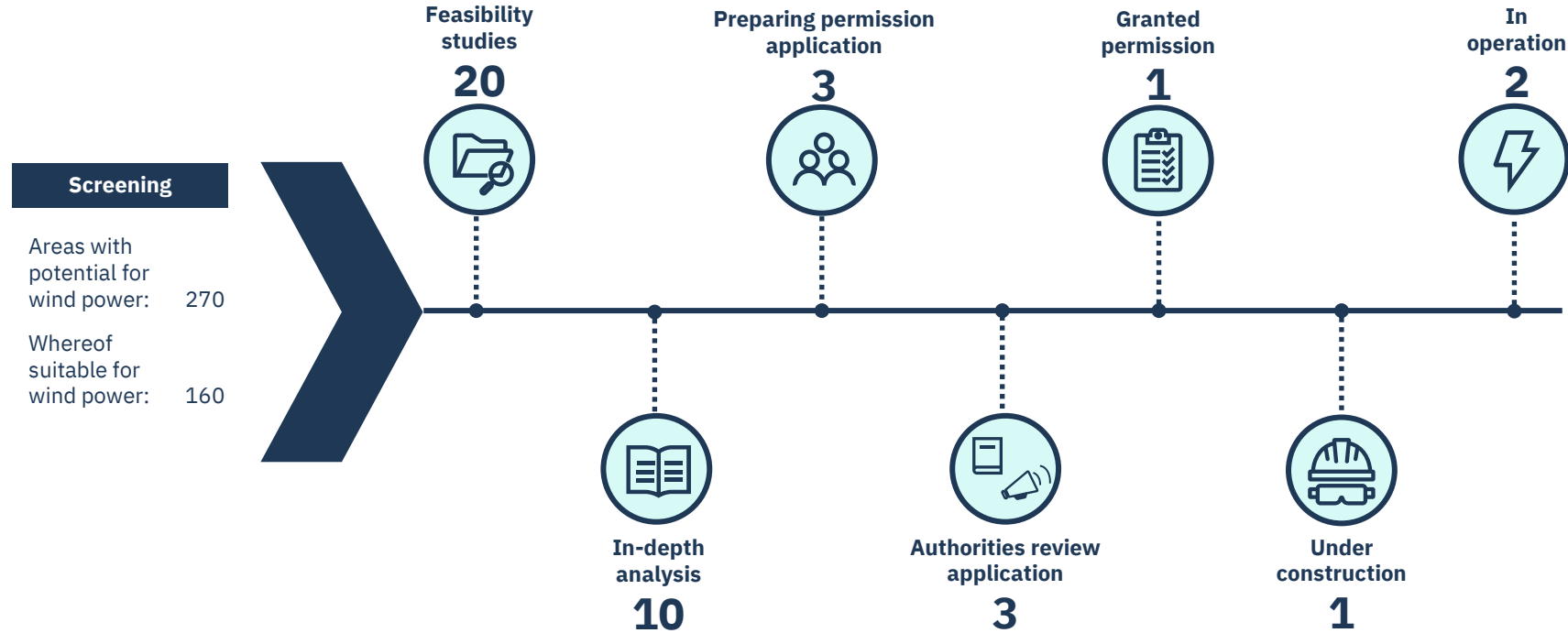

Historically low Swedish power prices in Q3

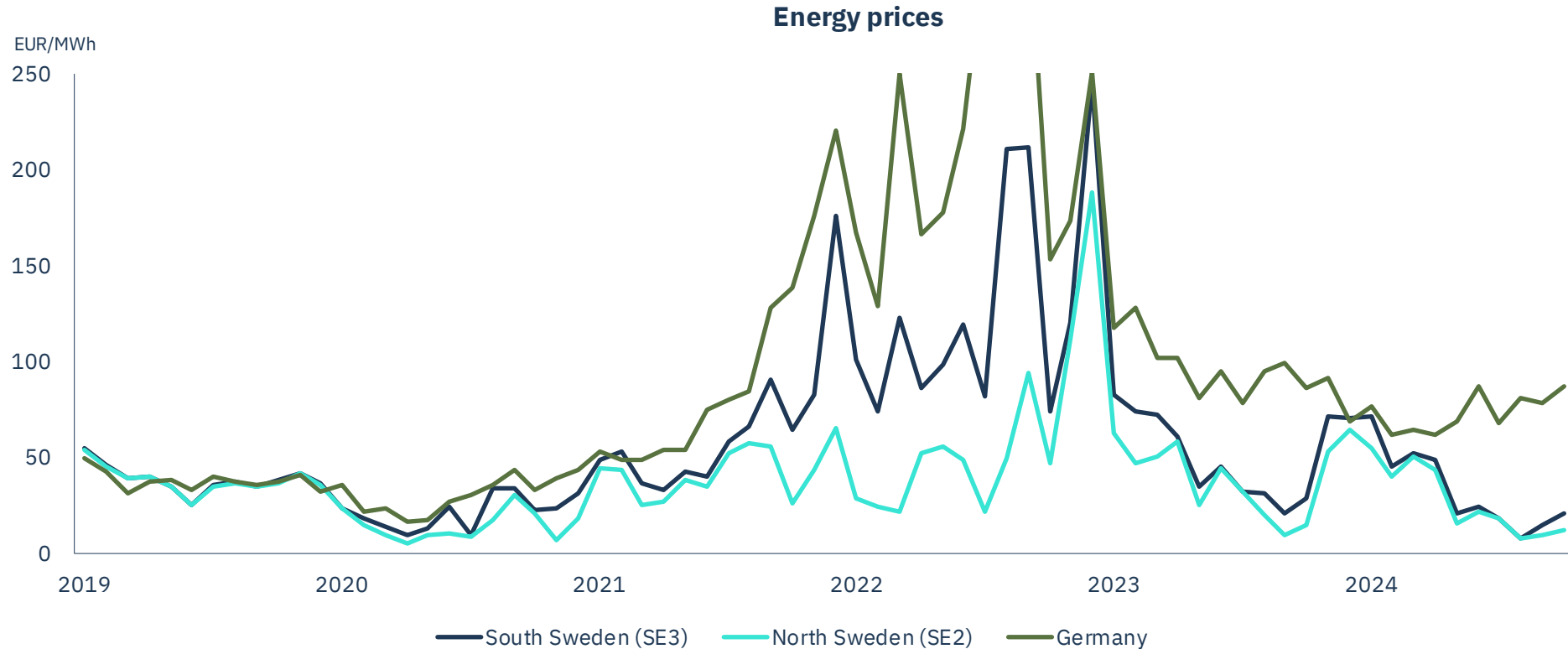

30% premium to market price over time

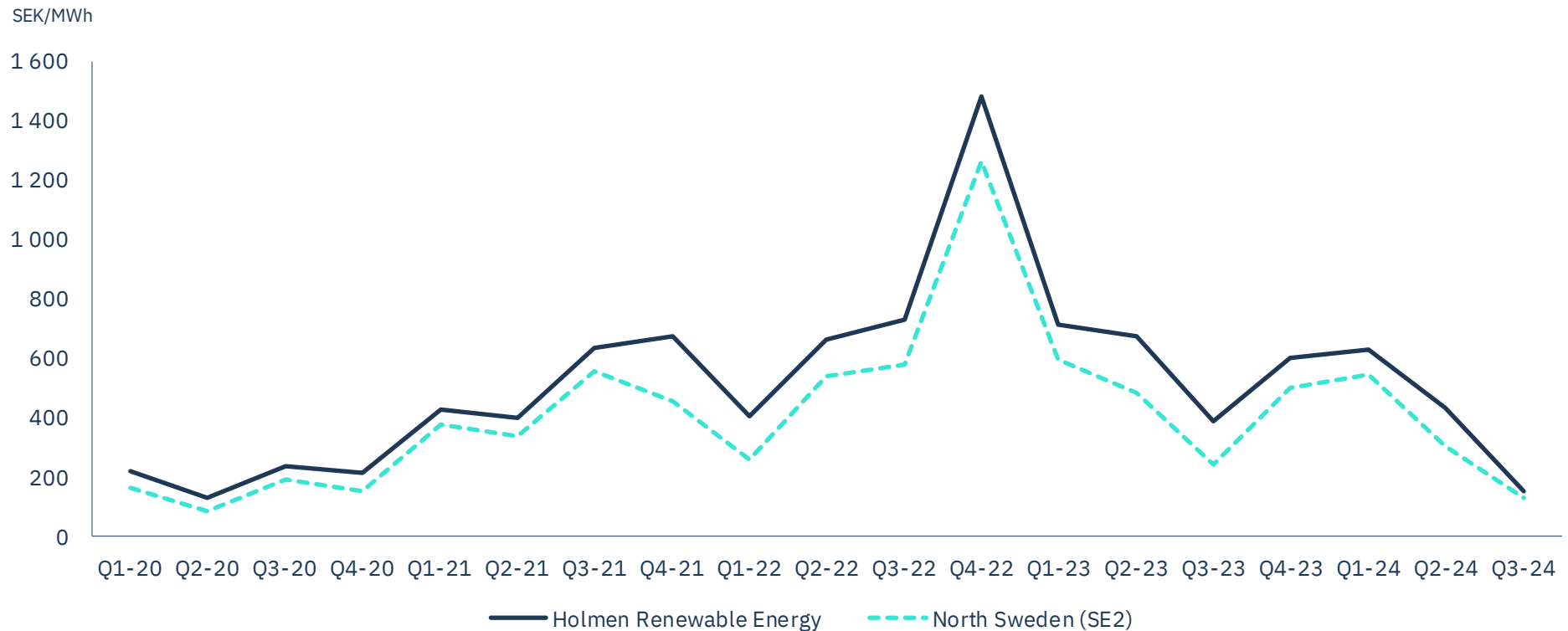

Price level insufficient to cover depreciation in Q3

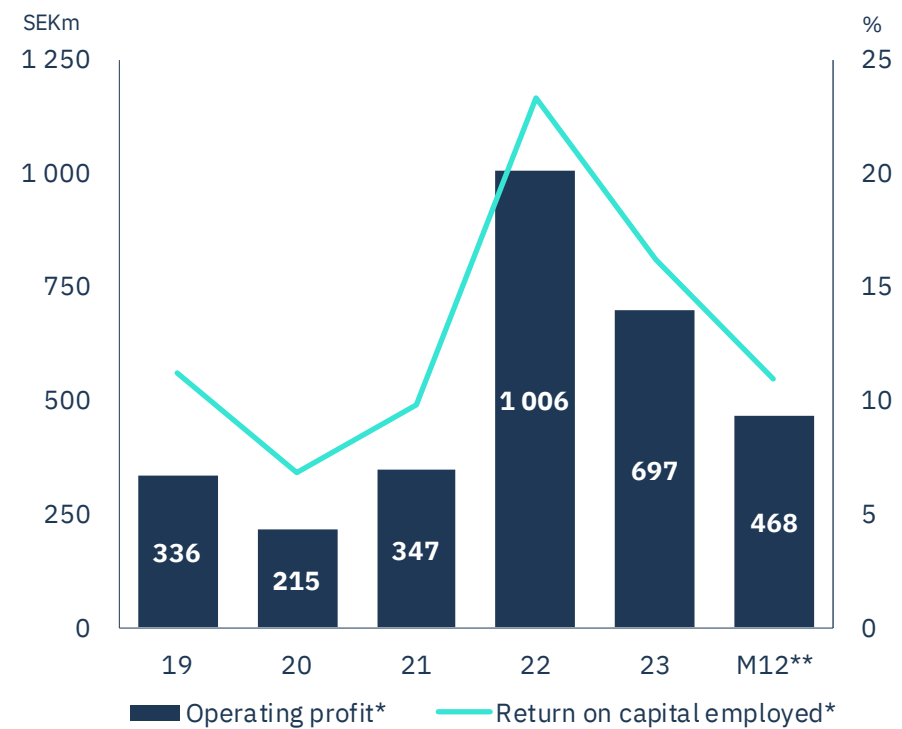
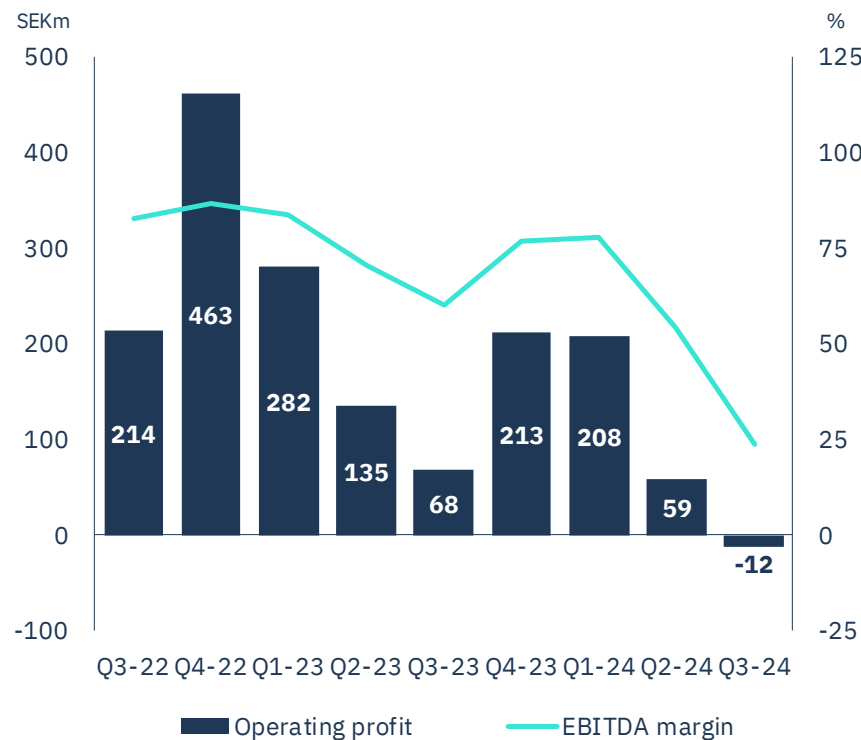

Forest

1.3 million ha total land area

1.0 million ha productive forest land



Real price increase of 1.7% p.a. last 20 years

Standing timber volume has grown by 0.6% per year

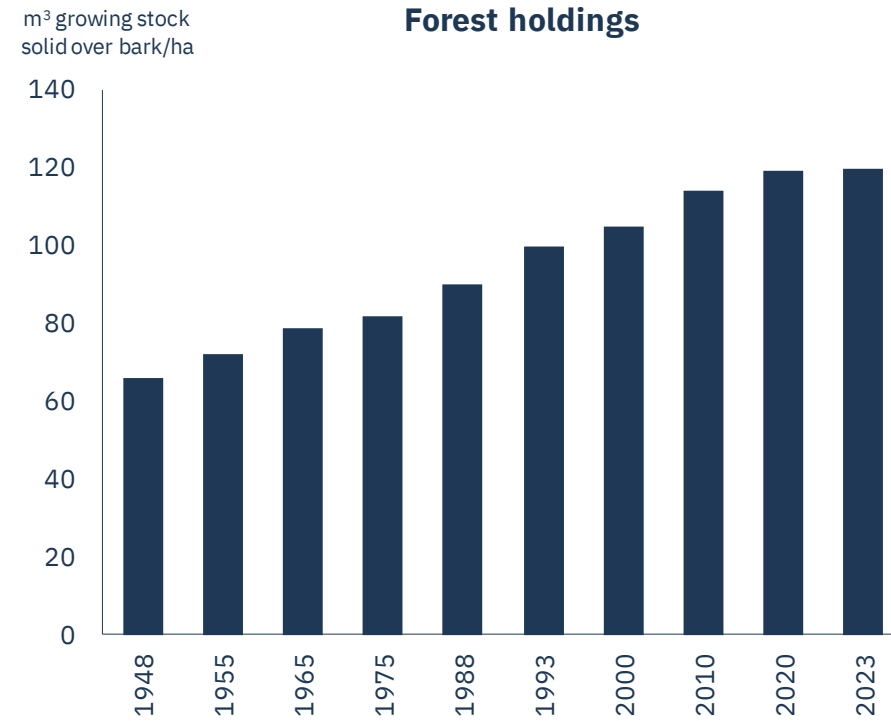
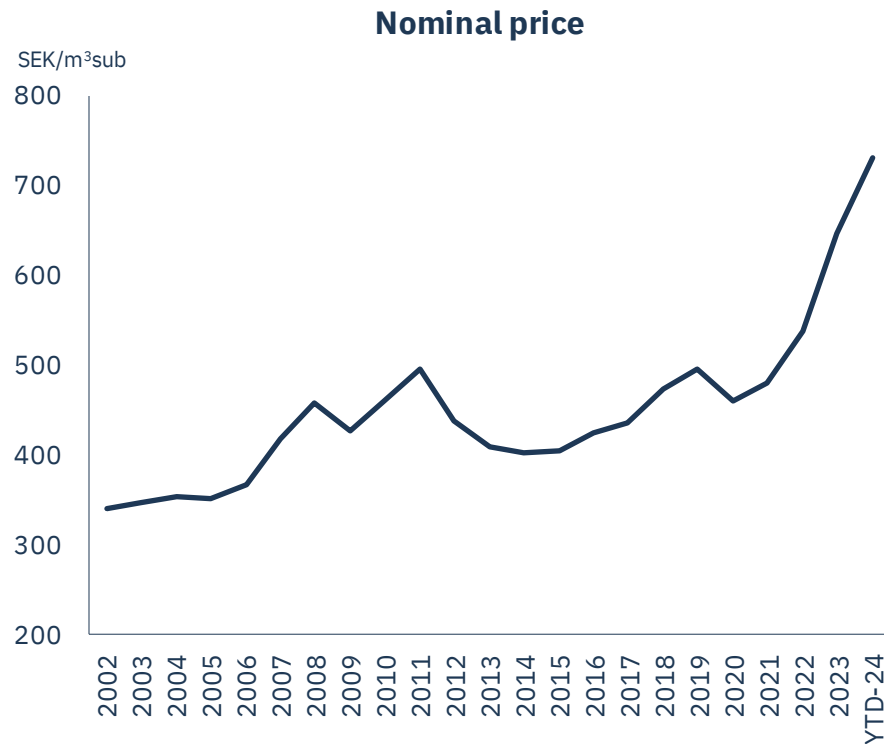

Growing forests with increased biodiversity

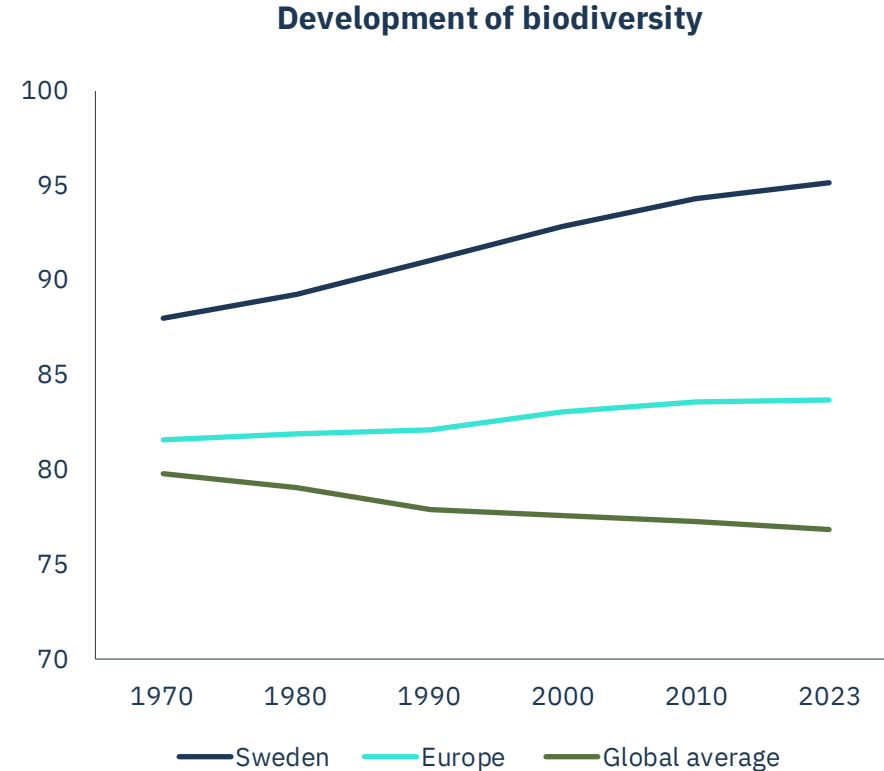
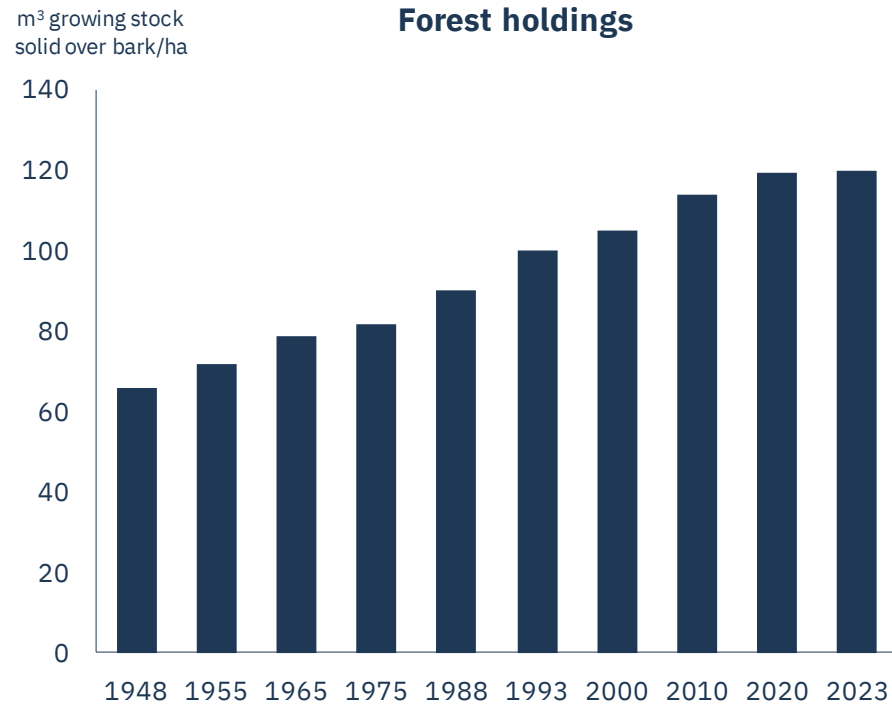

Still good mark-up on wood for pulp

Normal relationship between sawn wood & net log cost

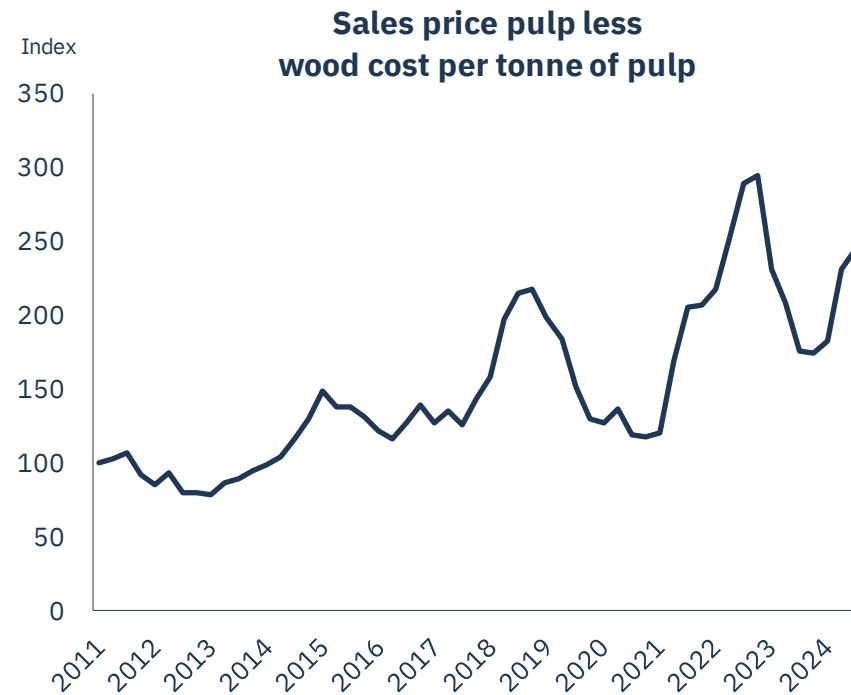
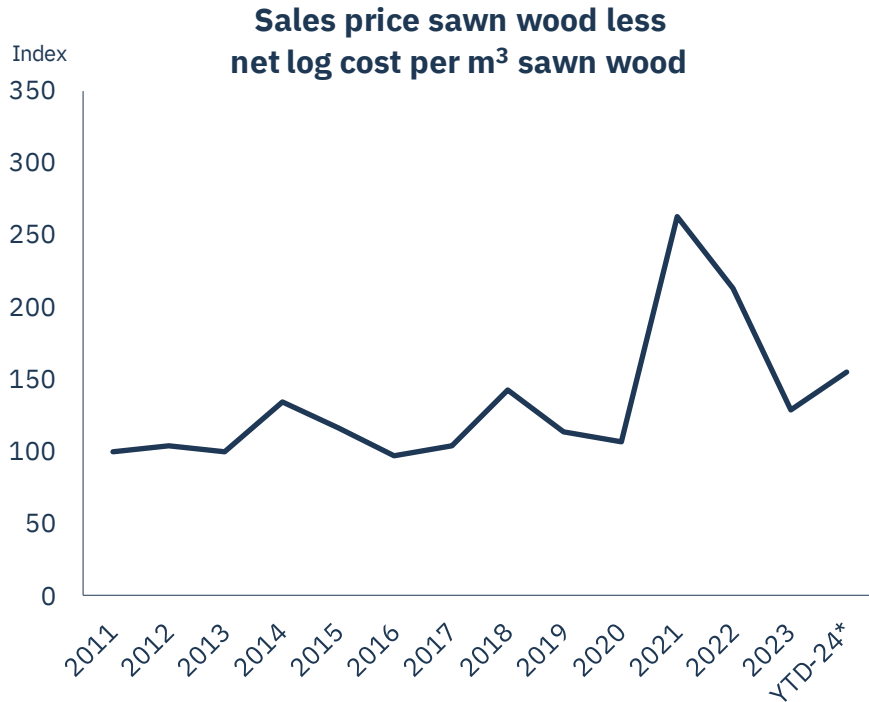

Price increases translating into higher profits

Harvesting cash-flow has increased 60% in 3 years

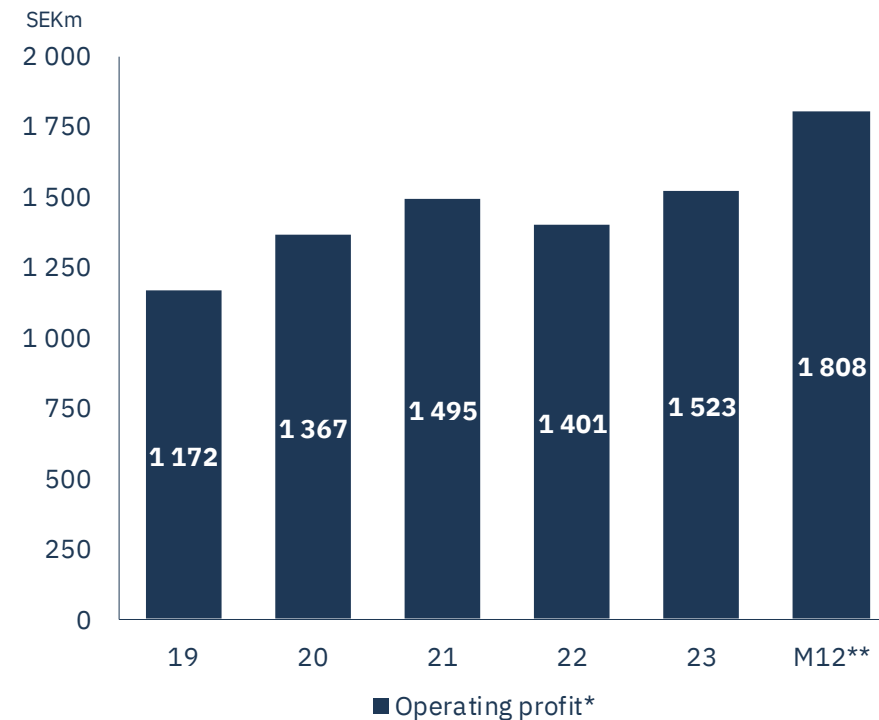
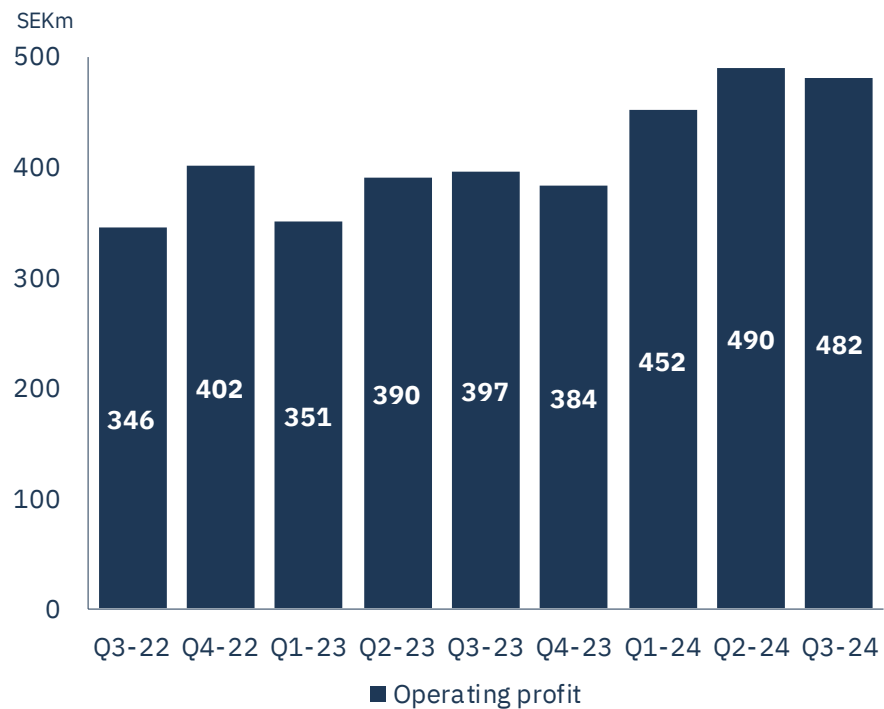

A photograph of a forest with a large, textured tree trunk in the foreground on the left. The background is filled with many other trees, some of which are blurred. The ground is covered with green moss and small plants. The text "Growing a sustainable future" is overlaid in the center in a bright cyan color.

Growing a sustainable future

We grow houses

Leftovers are converted into renewable packaging and paper
We harvest the energy that blows and runs through our forests

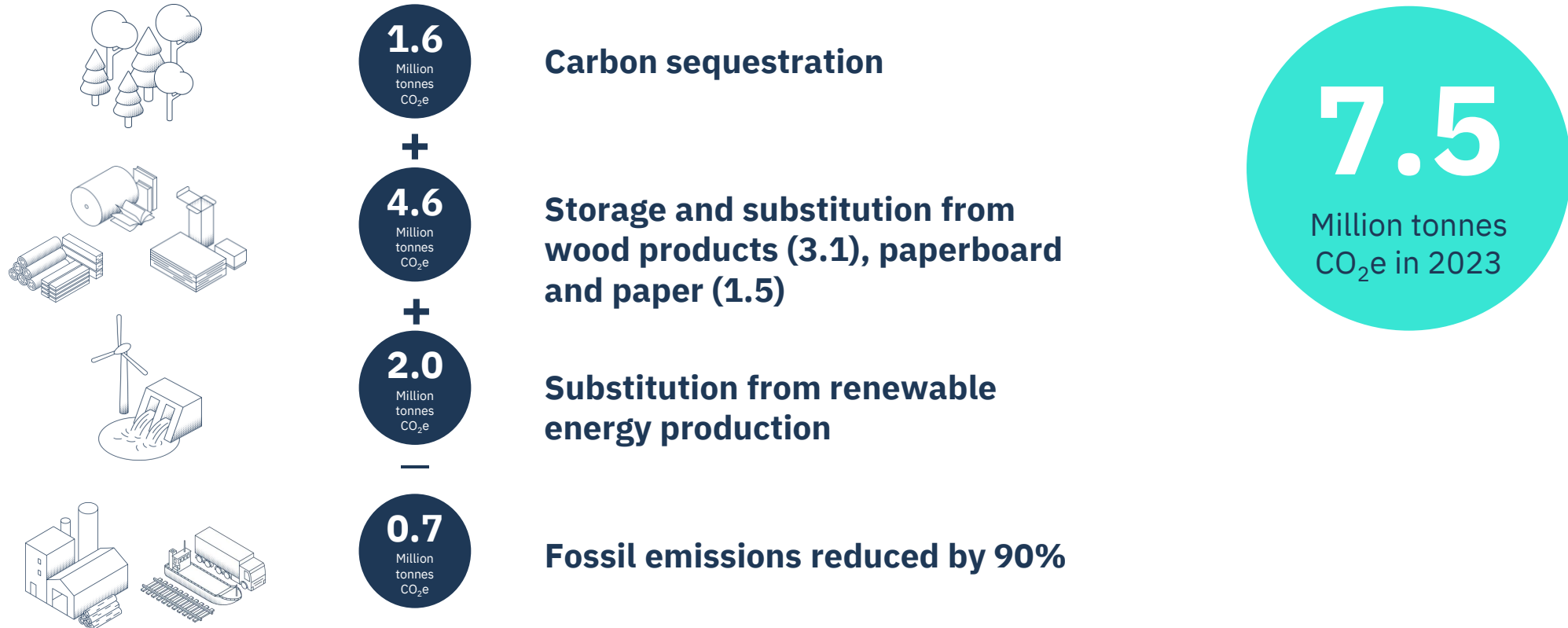

Increasing our contribution to the climate

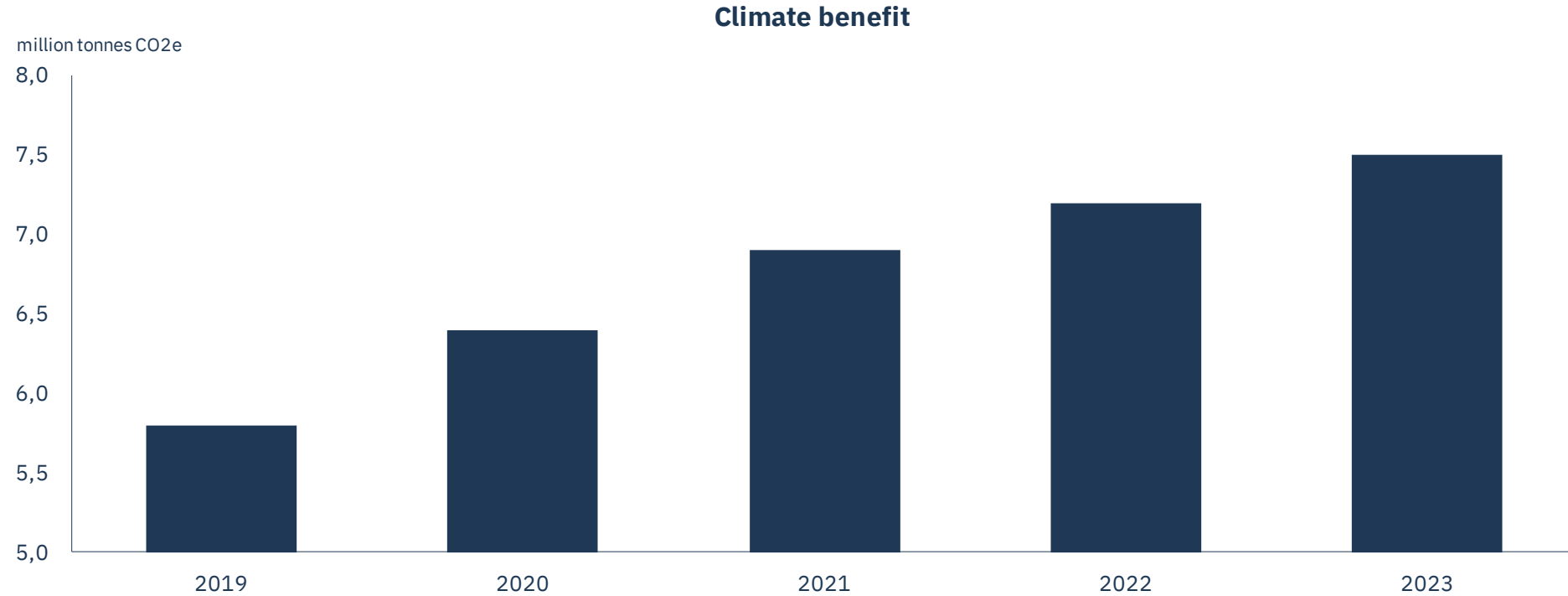

HOLMEN

holmen.com